

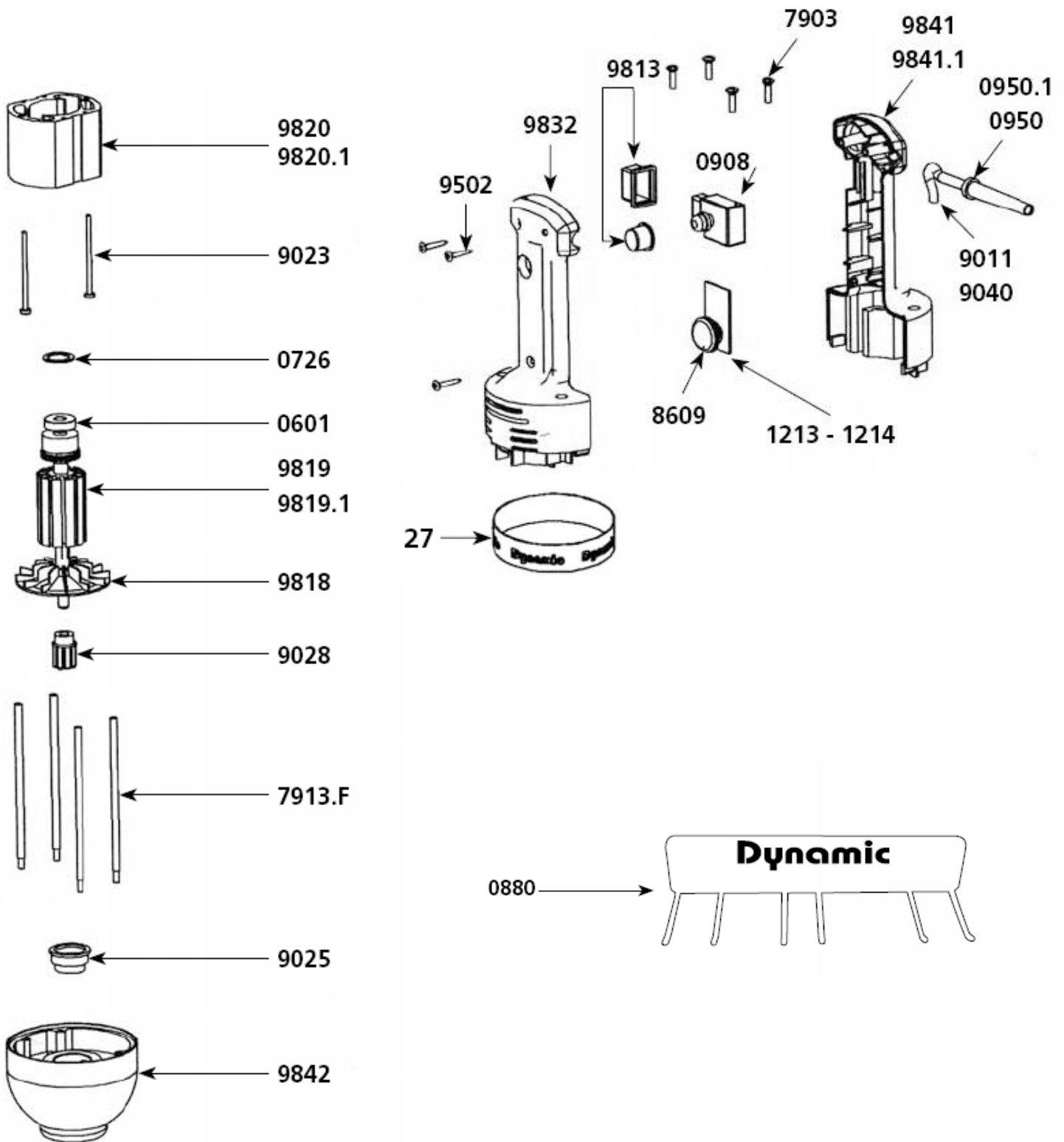



























Machine	Explode	Code	Description
Pmf – pmdh 250 mixer tool	0601	AD504	BALL BEARING
Pmf – pmdh 250 mixer tool	0607	☎	WATERPROOF SEAL
Pmf – pmdh 250 mixer tool	1189	☎	BEARING HOLDER + SEAL
Pmf – pmdh 250 mixer tool	7916	☎	LOWER BALL BEARING ASSEMBLY (W/ O SCREWS)
Pmf – pmdh 250 mixer tool	8313	AD518	CUTTER BLADE (W/ SCREW)
Pmf – pmdh 250 mixer tool	9051	AD529	COUPLING CASING + PINS
Pmf – pmdh 250 mixer tool	9843	☎	TUBE ASSEMBLY + BEARING
Pmf – pmdh 250 mixer tool	9844	AD577	SHAFT & COUPLING SLEEVE
Pmf – pmdh 250 mixer tool	9845	☎	SHAFT, LOWER BEARING & CUTTER ASSEMBLY
Pmf – pmdh 250 mixer tool	9902	☎	LOWER BEARING SCREWS (3)
Pmf – pmdh 250 mixer tool	AC006	☎	M 250 COMPLETE MIXER TOOL (SEE MACHINE CATALOGUE)



Machine	Explode	Code	Description
Pmdh/pmf 250 motor block	0514	AD575	CARBON BRUSHES (2)
Pmdh/pmf 250 motor block	0601	AD504	BALL BEARING
Pmdh/pmf 250 motor block	0726	AC148	SQUEEZING WASHER
Pmdh/pmf 250 motor block	0880		WALL BRACKET
Pmdh/pmf 250 motor block	0908	AD513	NON-LOCKING SWITCH
Pmdh/pmf 250 motor block	0909		CAPACITOR
Pmdh/pmf 250 motor block	0950		STRAIN RELIEF 230 V
Pmdh/pmf 250 motor block	0950.1		STRAIN RELIEF 115V
Pmdh/pmf 250 motor block	1017		WARNING LABEL
Pmdh/pmf 250 motor block	1027	AD573	DYNAMIC LABEL
Pmdh/pmf 250 motor block	1071		LABEL W/ SERIAL NUMBER 230 V
Pmdh/pmf 250 motor block	1072		LABEL W/ SERIAL NUMBER 115 V
Pmdh/pmf 250 motor block	1213	AD517	VARIABLE SPEED CONTROL BOARD 230 V
Pmdh/pmf 250 motor block	1214		VARIABLE SPEED CONTROL BOARD 115 V
Pmdh/pmf 250 motor block	7903		BRACE SCREWS (4)
Pmdh/pmf 250 motor block	7913.F		BRACES (4)
Pmdh/pmf 250 motor block	8609		VARIABLE SPEED CONTROL KNOB
Pmdh/pmf 250 motor block	9011		POWER CORD 230 V
Pmdh/pmf 250 motor block	9023		STATOR SCREWS (2)
Pmdh/pmf 250 motor block	9025	AB748	SELF-LUBRICATING RING
Pmdh/pmf 250 motor block	9028	AD496	COUPLER FOR ARMATURE
Pmdh/pmf 250 motor block	9040		POWER CORD 115 V
Pmdh/pmf 250 motor block	9502		HANDLE SCREWS (3)
Pmdh/pmf 250 motor block	9813	AD587	SWITCH PROTECTOR
Pmdh/pmf 250 motor block	9817		UPPER MOTOR CASING
Pmdh/pmf 250 motor block	9818		FAN
Pmdh/pmf 250 motor block	9819		ROTOR W/ O COUPLING 230 V
Pmdh/pmf 250 motor block	9819.1		ROTOR W/O COUPLING 115 V
Pmdh/pmf 250 motor block	9820		STATOR 230 V W/ CARTER, CARBON BRUSHES HOLDERS
Pmdh/pmf 250 motor block	9820.1		STATOR 115 V W/ CARTER, CARBON BRUSHES HOLDERS
Pmdh/pmf 250 motor block	9832		UPPER HALF HANDLE
Pmdh/pmf 250 motor block	9840		COMPLETE HANDLE 230 V
Pmdh/pmf 250 motor block	9840.1		COMPLETE HANDLE 115 V
Pmdh/pmf 250 motor block	9841		LOWER HALF HANDLE W/ LABEL 230 V
Pmdh/pmf 250 motor block	9841.1		LOWER HALF HANDLE W/ LABEL 115 V
Pmdh/pmf 250 motor block	9842		ALUMINIUM CARTER + BALL BEARING
Pmdh/pmf 250 motor block	AC005		BM 250 MOTOR BLOCK (SEE MACHINE CATALOGUE)