

























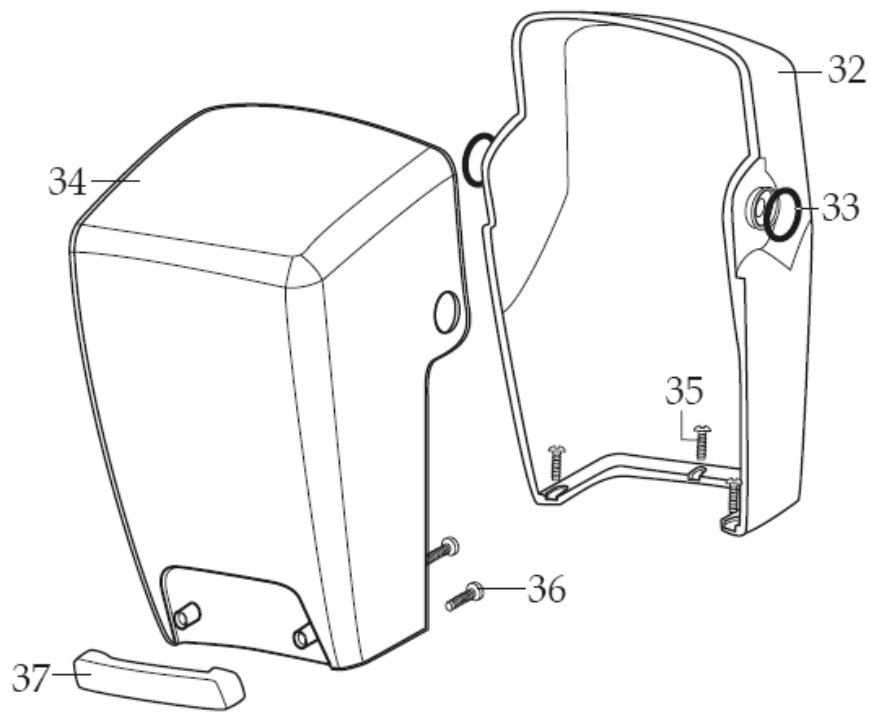

Machine	Explode	Code	Description
Waring Xtreme Hi-Power Blender		DM876	WARING STACKING MX JAR
Waring Xtreme Hi-Power Blender		AC900	STACKABLE POLYCARBONATE CONTAINER WITH LID - 48OZ
Waring Xtreme Hi-Power Blender	1	See	JAR LID COVER
Waring Xtreme Hi-Power Blender	2		JAR LID
Waring Xtreme Hi-Power Blender	3	DM876	JAR ONLY / 64 OZ. STACKABLE JAR WITH BLENDING ASSY. / 64 OZ. STACKABLE
Waring Xtreme Hi-Power Blender	4		BLADE ASSY.
Waring Xtreme Hi-Power Blender	5		BEARING HOLDER O RING
Waring Xtreme Hi-Power Blender	6		NUT GASKET
Waring Xtreme Hi-Power Blender	7		BEARING HOLDER NUT
Waring Xtreme Hi-Power Blender	8	AC930	DRIVE CLUTCH
Waring Xtreme Hi-Power Blender	9		JAR PAD
Waring Xtreme Hi-Power Blender	9a		JAR PAD / SOUND ENCLOSURE
Waring Xtreme Hi-Power Blender	10		MOTOR
Waring Xtreme Hi-Power Blender	11	AC932	DAMPENING PLATE GASKET
Waring Xtreme Hi-Power Blender	12		TOP HOUSING / BLACK
Waring Xtreme Hi-Power Blender	13		MOTOR FOAM 2 REQ.'D
Waring Xtreme Hi-Power Blender	14		DAMPENING PLATE BUSHING 4 REQ.'D
Waring Xtreme Hi-Power Blender	15		DAMPENING PLATE SLEEVE 4 REQ.'D
Waring Xtreme Hi-Power Blender	16		WASHER 2 REQ.'D
Waring Xtreme Hi-Power Blender	17		SCREW 4 REQ.'D
Waring Xtreme Hi-Power Blender	18	AC940	CONTROL PANEL
Waring Xtreme Hi-Power Blender	19		HOUSING FOAM BAFFLE/ REAR
Waring Xtreme Hi-Power Blender	20		HOUSING FOAM BAFFLE/ FRONT
Waring Xtreme Hi-Power Blender	21		MOTOR HOUSING
Waring Xtreme Hi-Power Blender	22		WASHER 3 REQ.'D
Waring Xtreme Hi-Power Blender	23		BOTTOM HOUSING FOAM BAFFLE
Waring Xtreme Hi-Power Blender	24		FOAM BAFFLE
Waring Xtreme Hi-Power Blender	25		CABLE TIE 3 REQ.'D
Waring Xtreme Hi-Power Blender	26	AC934	CORD SET
Waring Xtreme Hi-Power Blender	27		STRAIN RELIEF
Waring Xtreme Hi-Power Blender	28		BOTTOM HOUSING/ BLACK
Waring Xtreme Hi-Power Blender	29	AC938	SCREW 4 REQ.'D
Waring Xtreme Hi-Power Blender	30		CORNER POST 4 REQ.'D
Waring Xtreme Hi-Power Blender	31		SCREW 4 REQ.'D
Waring Xtreme Hi-Power Blender	503351		MX COUPLING WRENCH
Waring Xtreme Hi-Power Blender	503392		SPANNER WRENCH (OPTIONAL)



Machine	Explode	Code	Description
Waring Xtreme Hi-Power Blender	32	☎	INNER SOUND ENCLOSURE / SE1000
Waring Xtreme Hi-Power Blender	33	☎	"O" RING 2 REQ.'D
Waring Xtreme Hi-Power Blender	34	☎	OUTER SOUND ENCLOSURE/ SE1000
Waring Xtreme Hi-Power Blender	35	AC937	SCREW 3 REQ.'D
Waring Xtreme Hi-Power Blender	36	AC938	SCREW 2 REQ.'D
Waring Xtreme Hi-Power Blender	37	AC939	SOUND ENCLOSURE HANDLE